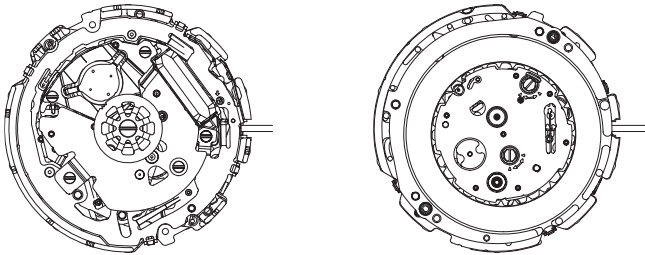

PARTS CATALOGUE/TECHNICAL GUIDE

Cal. 7L22A

[SPECIFICATIONS]

Item		Cal. No.	7L22A
Movement			
Movement size	Outside diameter		ø32.0 mm
	Casing diameter		ø30.0 mm
	Height		6.4 mm
Time indication (Movement intervals)			Main time : Hour, minute and small second hands (1second)
			Stopwatch : Stopwatch minute and 1/5 second hands (0.2 second)
Driving system			Step motor, 2 pieces (Load compensated driving pulse type)
Additional mechanism			<ul style="list-style-type: none"> • Electronic circuit reset switch • Train wheel setting device • Date calendar • Instant setting device for day calendar • Automatic generating system • Energy depletion forewarning function • Overcharge prevention function <p>• Stopwatch function 45 minutes measurement in 1/5 second increments Accumulated elapsed time measurement Heartcam fly-back Reset</p>
Loss/gain			Monthly rate within normal temperature range: less than 15 seconds
Regulation system			Nil
Measuring gate by quartz tester			10-second gate
Power Supply	Power generator		Automatic generating system
	KINETIC E.S.U		Titanium lithium ion rechargeable battery
Operating voltage range			0.45 ~ 2.5 V
Duration of operation			From full charge to stoppage : Approximately 5 months
Jewels			8 jewels

BEFORE STARTING REPAIR WORK ON 7L22A

Before starting repairs, read this manual carefully to understand the features of this watch and strictly observe the instructions regarding how to perform repairs and checks in order to ensure appropriate work is carried out.

Features of Cal. 7L22A

The Cal. 7L22A is a fully-fledged chronograph featuring a Kinetic Automatic Generating System. 5M6 series parts are used for the Automatic Generating System and 7N series parts are used for the wheels and motors.

1. Stopwatch functions

- ◆ The stopwatch is designed to time up to 45 minutes in 1/5 second increments.
- ◆ The measured time is indicated by two stopwatch hands.
- ◆ After timing for 45 minutes, it continues timing up until 48 minutes before automatically stopping.
- ◆ The stopwatch can be reset even while it is currently timing.

◆ Stopwatch Operation:

Button A : Start/ Stop

Button B : Reset

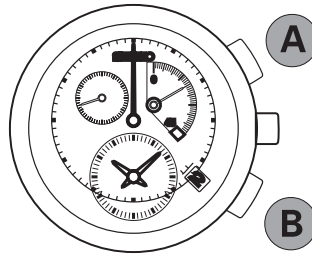

◆ Heartcam Chronograph Reset:

The two stopwatch hands are instantaneously reset to the zero position.

◆ Measuring methods:

Standard measurement

Accumulated elapsed time measurement





2. Kinetic features

- ◆ The watch will keep operating for approximately 5 months when fully charged under the condition that the stopwatch is used for no longer than for 45 minutes per day.
- ◆ **Energy Depletion Forewarning Function**
When energy is running low, the small second hand will start moving in two-second intervals to indicate recharging is required. If the watch is not recharged at this time, it will run down within approximately 12 hours after the initial forewarning.
- ◆ Gently swing the stopped watch from side to side at least five hundred times until it returns to its normal one-second intervals from the two-second intervals.

Disassembling procedures Figs. : ① → ⑧⑤

Reassembling procedures Figs. : ⑧⑤ → ①

Lubricating : Types of oil Oil quantity

	Moebius A		Normal quantity
	Moebius F		Large quantity
	SEIKO Watch Oil S-6		

Remarks

When removing the movement from the case or releasing the setting stem during repairs, make sure that the crown is pushed in to the zero position (its original position) and then gently push down on the setting lever to remove the movement from the setting stem.

To comply with the new structure of the Cal.7L22, an exclusive movement holder should always be used for disassembly and reassembly.

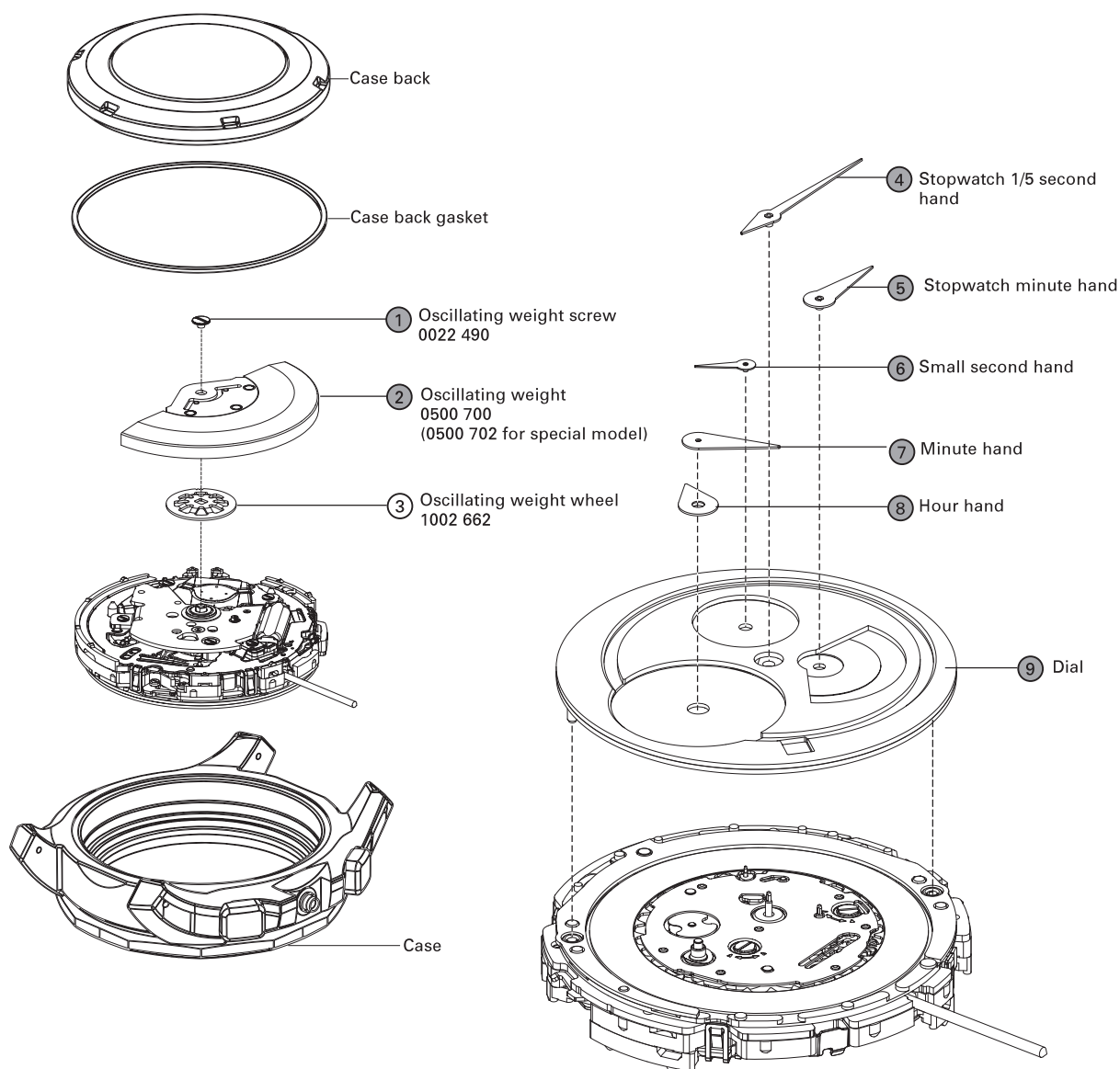

 → Please see the remarks on the following pages.
Lubricating of some parts is shown in "II. REMARKS ON DISASSEMBLING AND REASSEMBLING".

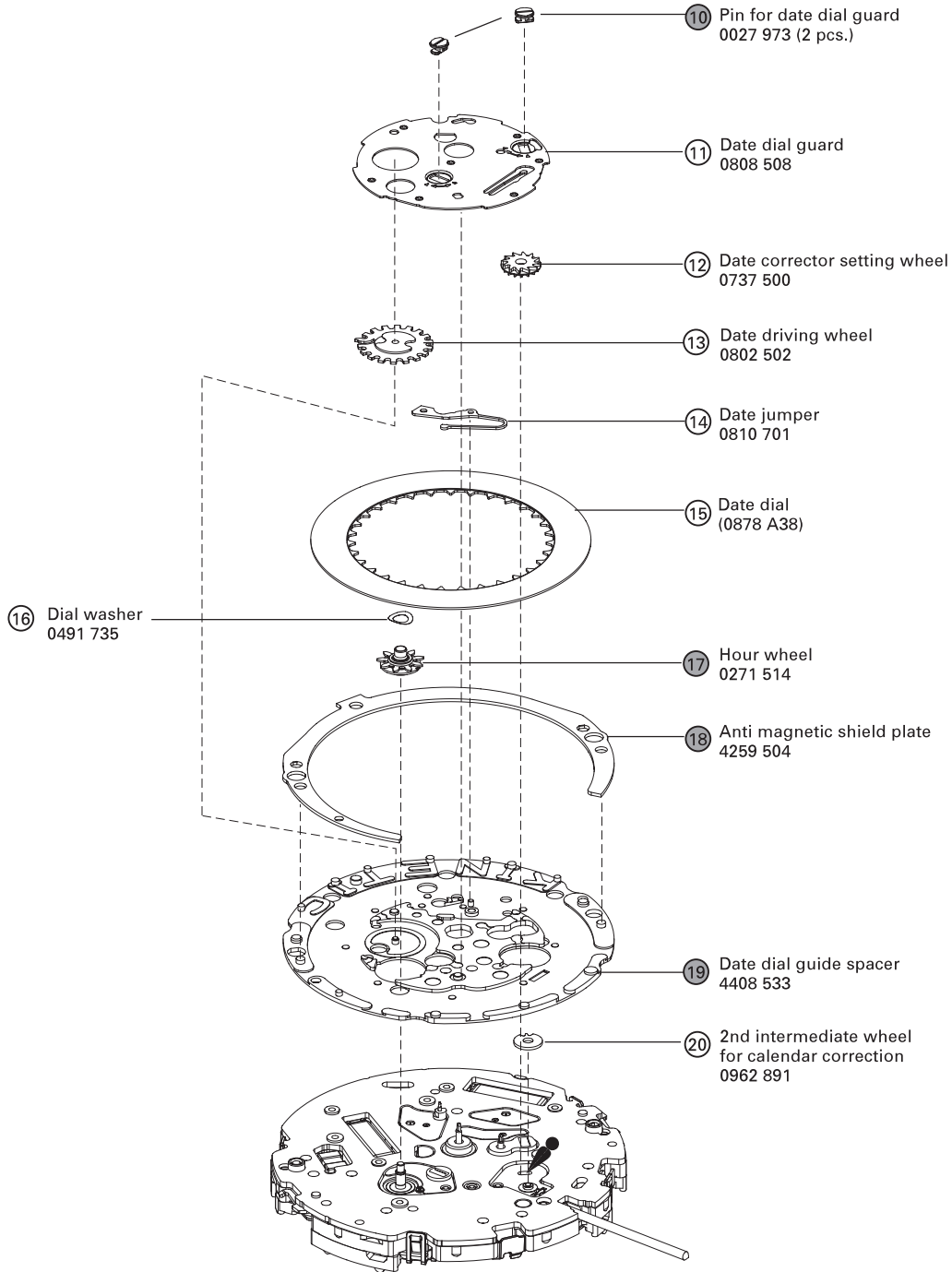

● ➔ Please see the remarks on the following pages.
Lubricating of some parts is shown in "II. REMARKS ON DISASSEMBLING AND REASSEMBLING".

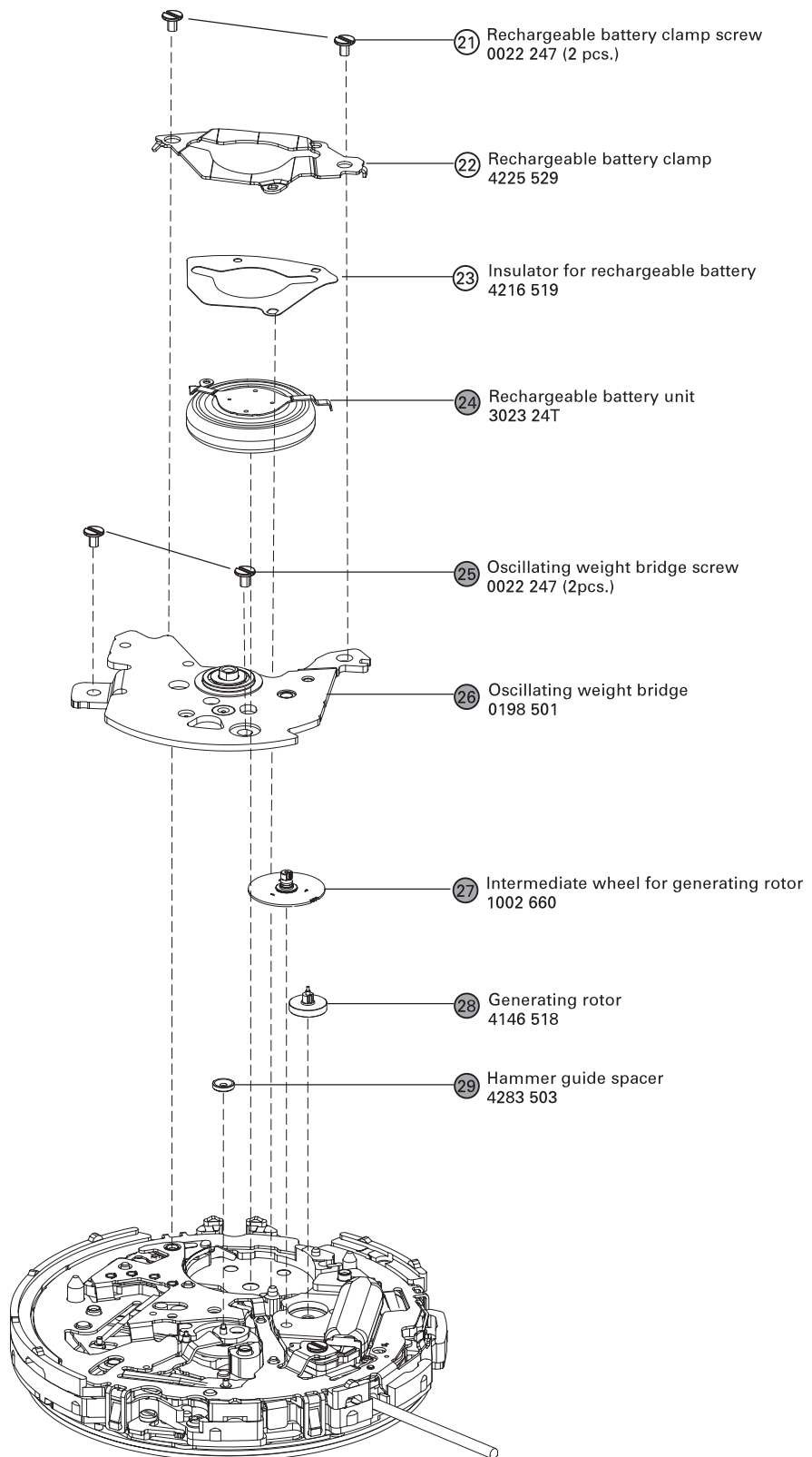

Please see the remarks on the following pages.

Lubricating of some parts is shown in "II. REMARKS ON DISASSEMBLING AND REASSEMBLING".

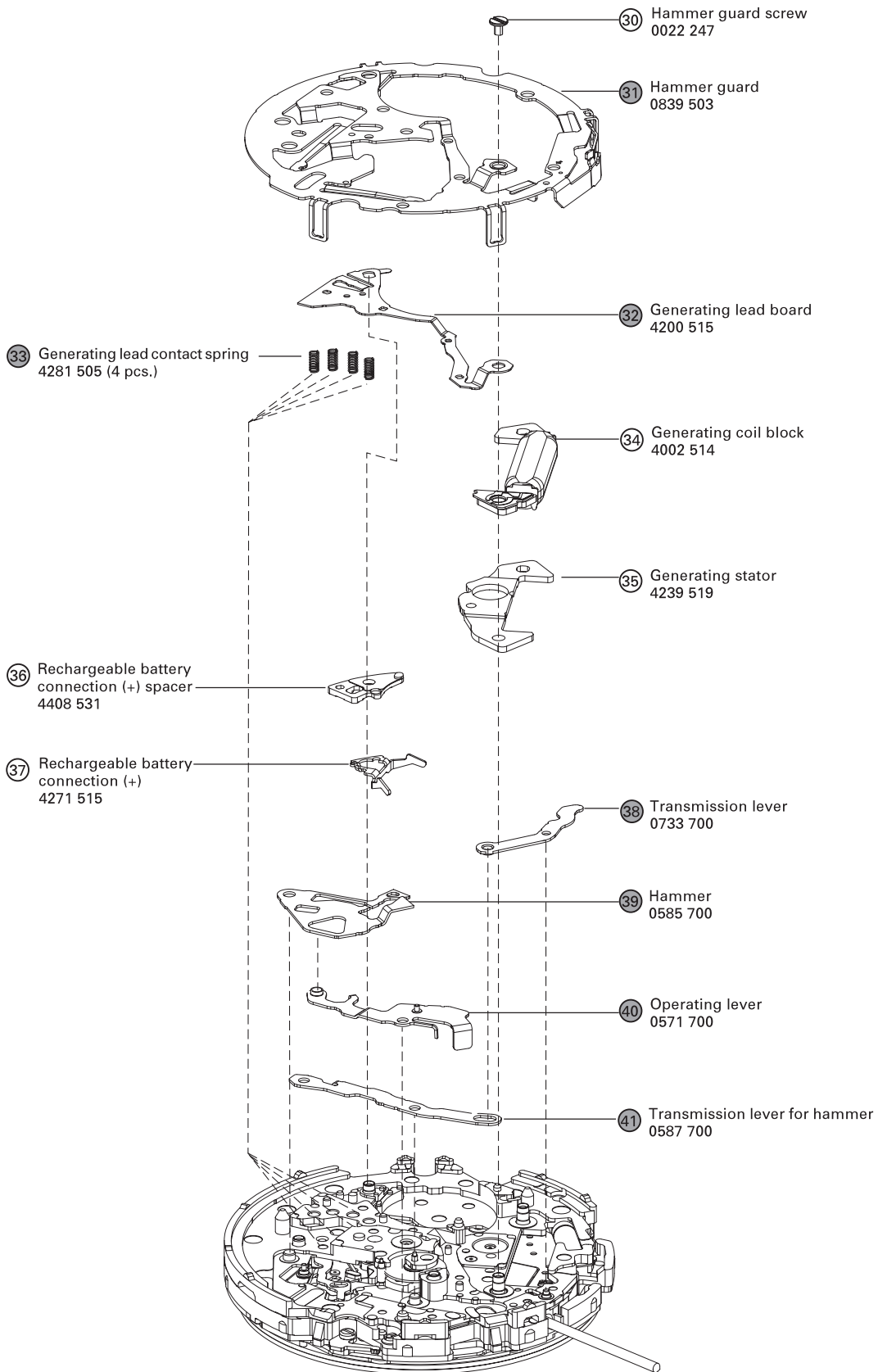

➡ Please see the remarks on the following pages.
Lubricating of some parts is shown in "II. REMARKS ON DISASSEMBLING AND REASSEMBLING".

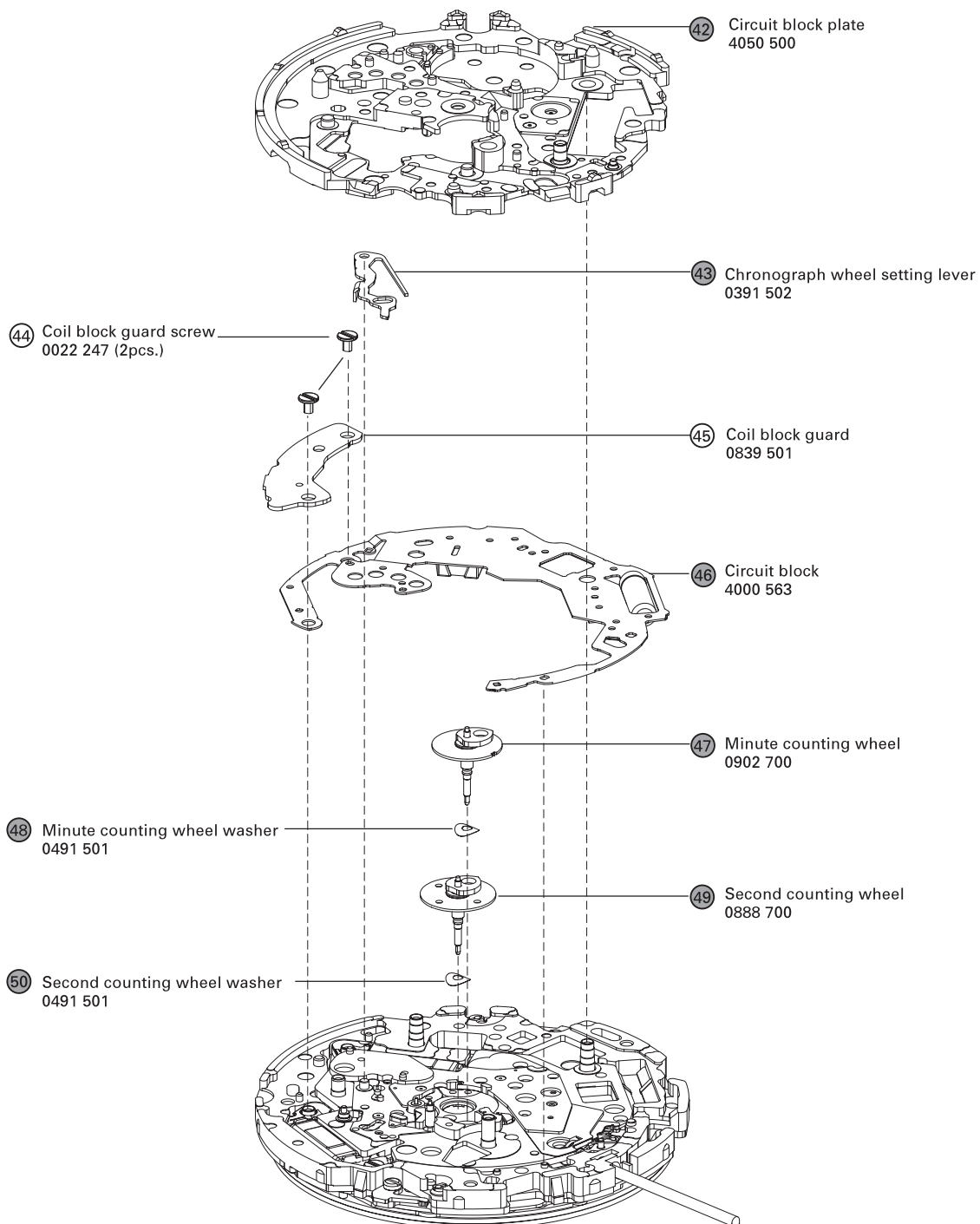

● ➡ Please see the remarks on the following pages.
Lubricating of some parts is shown in "II. REMARKS ON DISASSEMBLING AND REASSEMBLING".

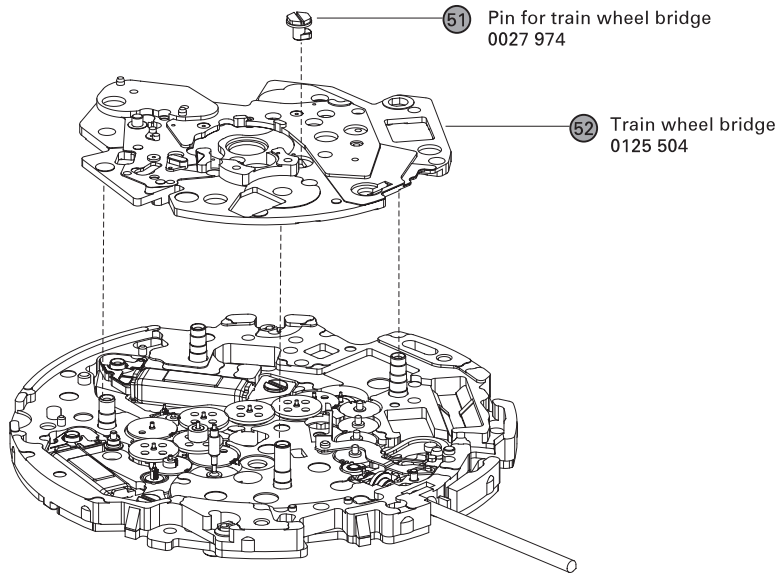

51 Pin for train wheel bridge
0027 974

52 Train wheel bridge
0125 504

54 2nd intermediate wheel
for second-counting
0817 505

55 3rd intermediate wheel
for second-counting
0701 904

58 Rotor for chronograph
4146 886

53 1st intermediate wheel
for second-counting
0885 701

56 2nd intermediate wheel
for minute-counting
0231 904

57 1st intermediate wheel
for minute-counting
0885 700

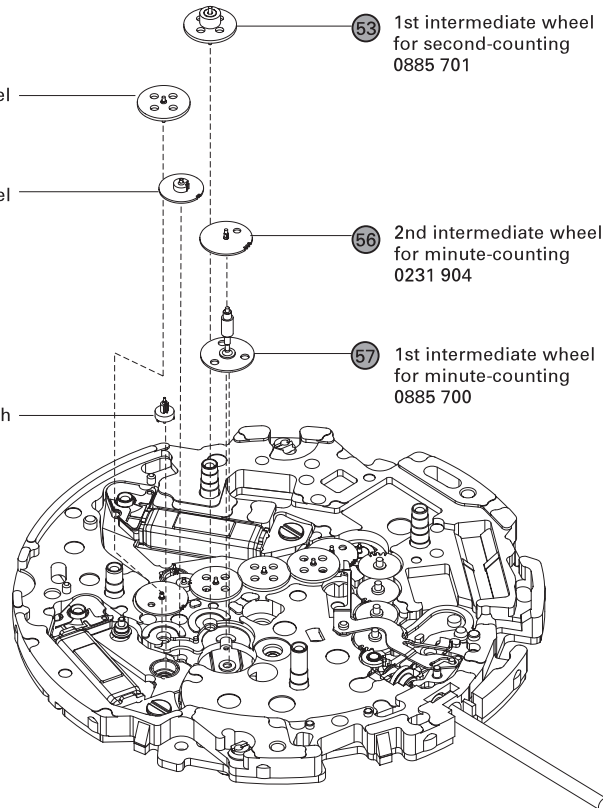

Please see the remarks on the following pages.
Lubricating of some parts is shown in "II. REMARKS ON DISASSEMBLING AND REASSEMBLING".

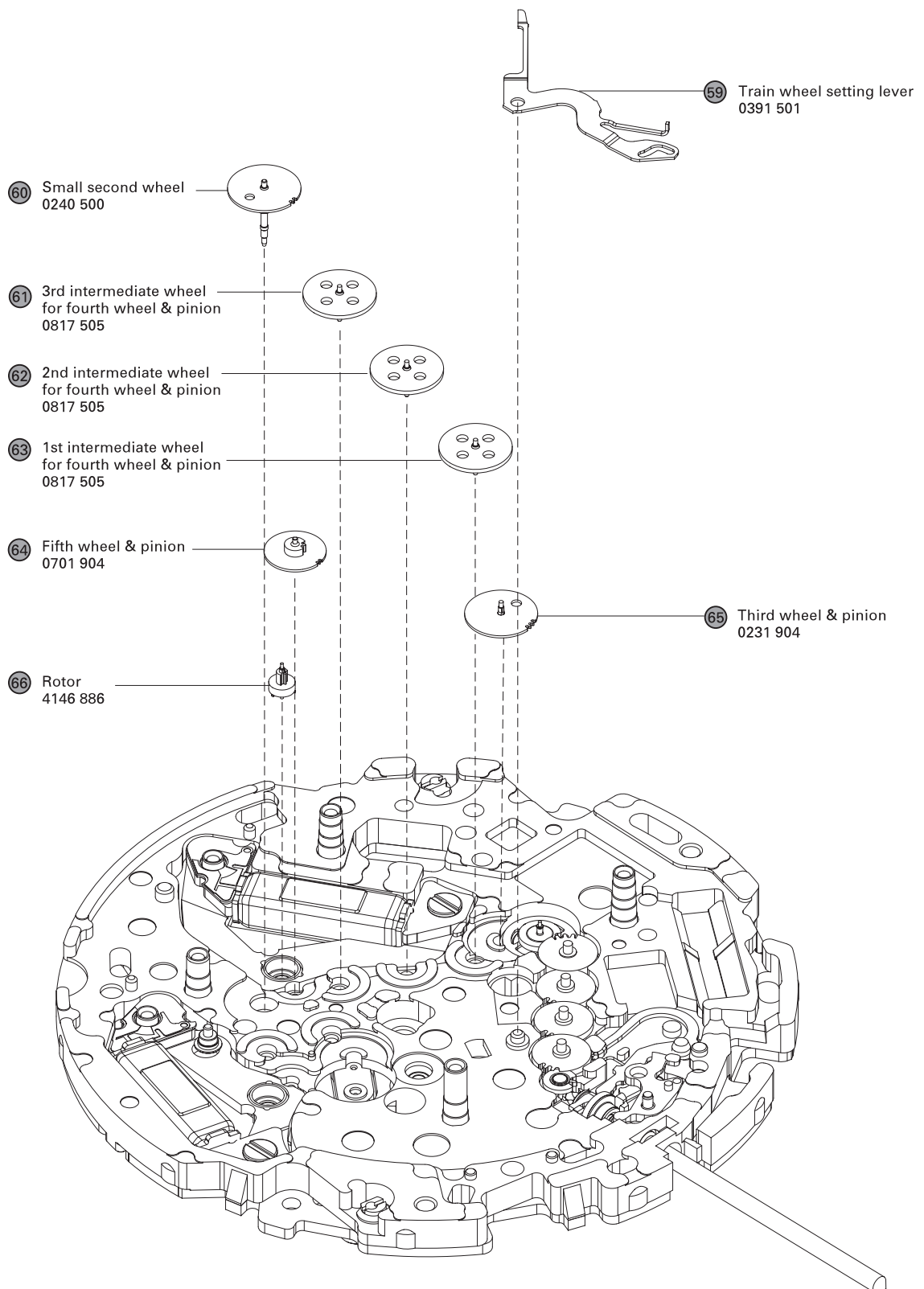

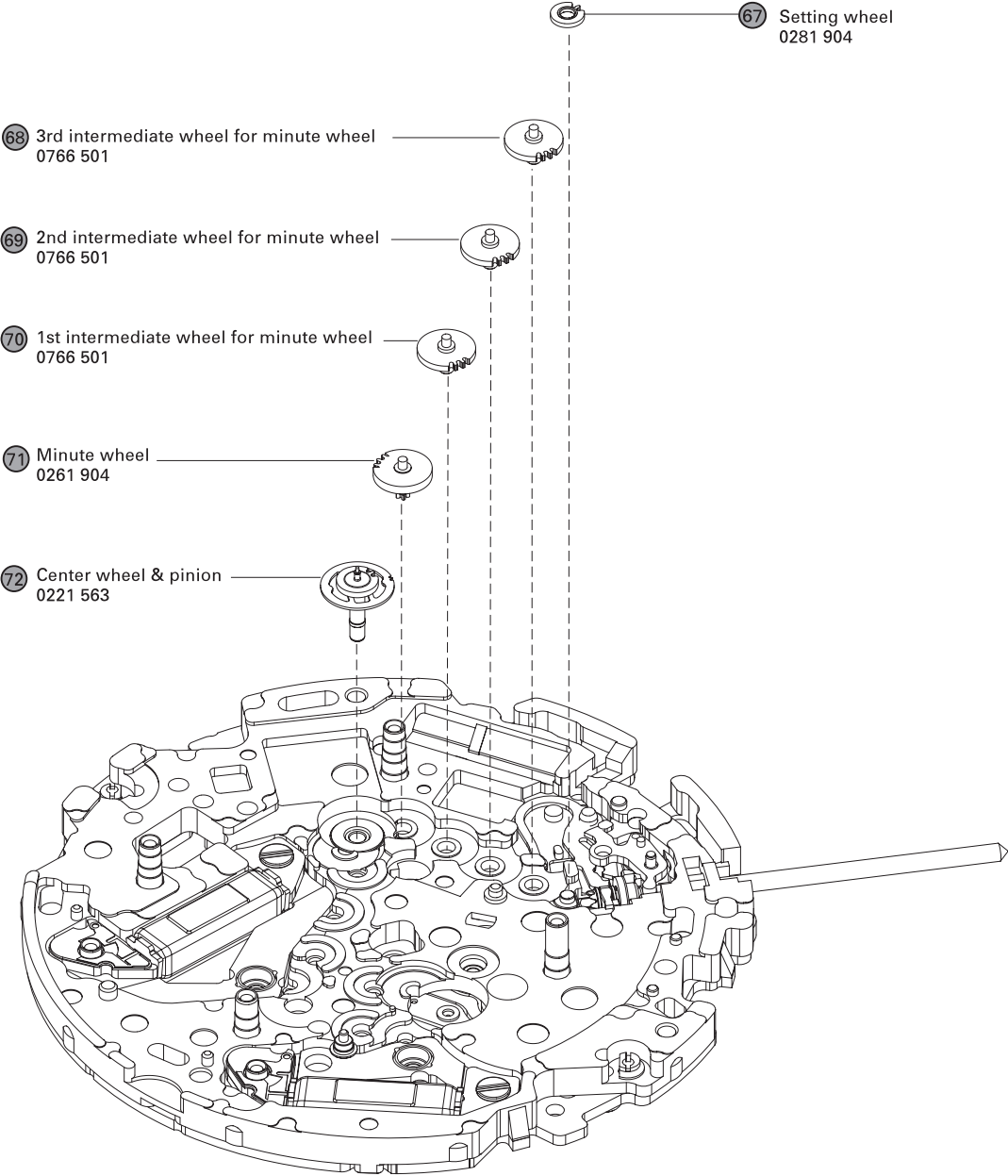

➔ Please see the remarks on the following pages.
Lubricating of some parts is shown in "II. REMARKS ON DISASSEMBLING AND REASSEMBLING".

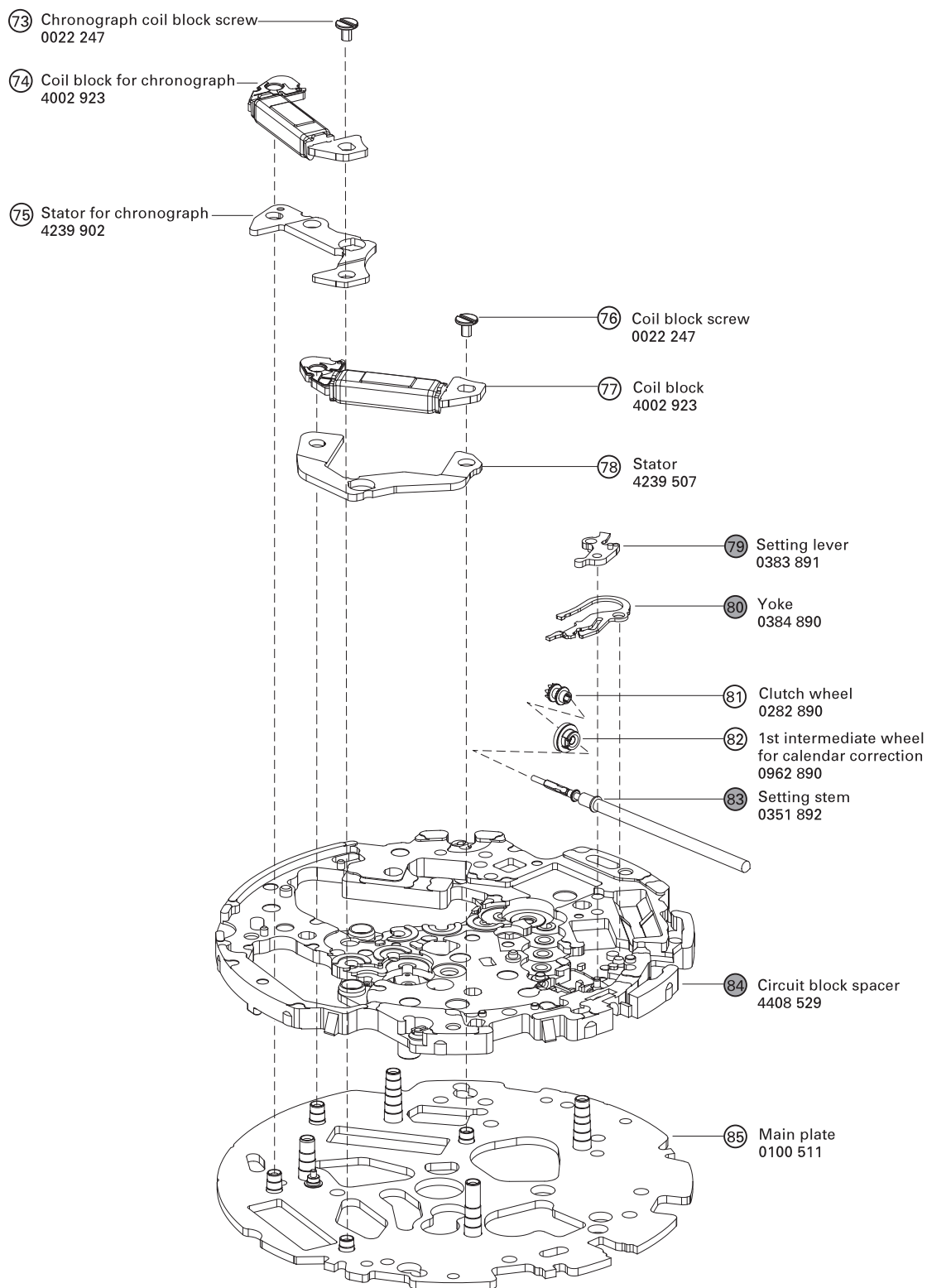

● ➔ Please see the remarks on the following pages.
Lubricating of some parts is shown in "II. REMARKS ON DISASSEMBLING AND REASSEMBLING".



  Please see the remarks on the following pages.
Lubricating of some parts is shown in "II. REMARKS ON DISASSEMBLING AND REASSEMBLING".

Remarks

② Oscillating weight 0500 700

Unless otherwise specified, use the oscillating weight (0500 700) for ordinary models.
For some particular models, the oscillating weight for special model (0500 702) are provided. (Refer to the illustration below.)



* Never use the oscillating weight for special model (0500 702) for models other than the specified ones.

⑮ Date dial

Parts code	Crown position	Calendar frame position	Color of figure	Color of background
0878 A37	3 o'clock	around 4 o'clock	white	black
0878 A38	3 o'clock	around 4 o'clock	black	white

⑧③ Setting stem 0351 892

The type of date dial and setting stem are determined based on the case design.
Check the case number and refer to "SEIKO Casing Parts Catalogue" to choose the appropriate ones.

⑩ Pin for date dial guard 0027 973

⑤① Pin for train wheel bridge 0027 974

For distinction between those pins, see the illustration below.

Pin for date dial guard
0027 973

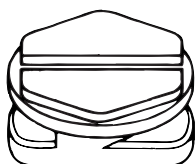

Pin for train wheel bridge
0027 974

